

18歳以下男子シングルス本選

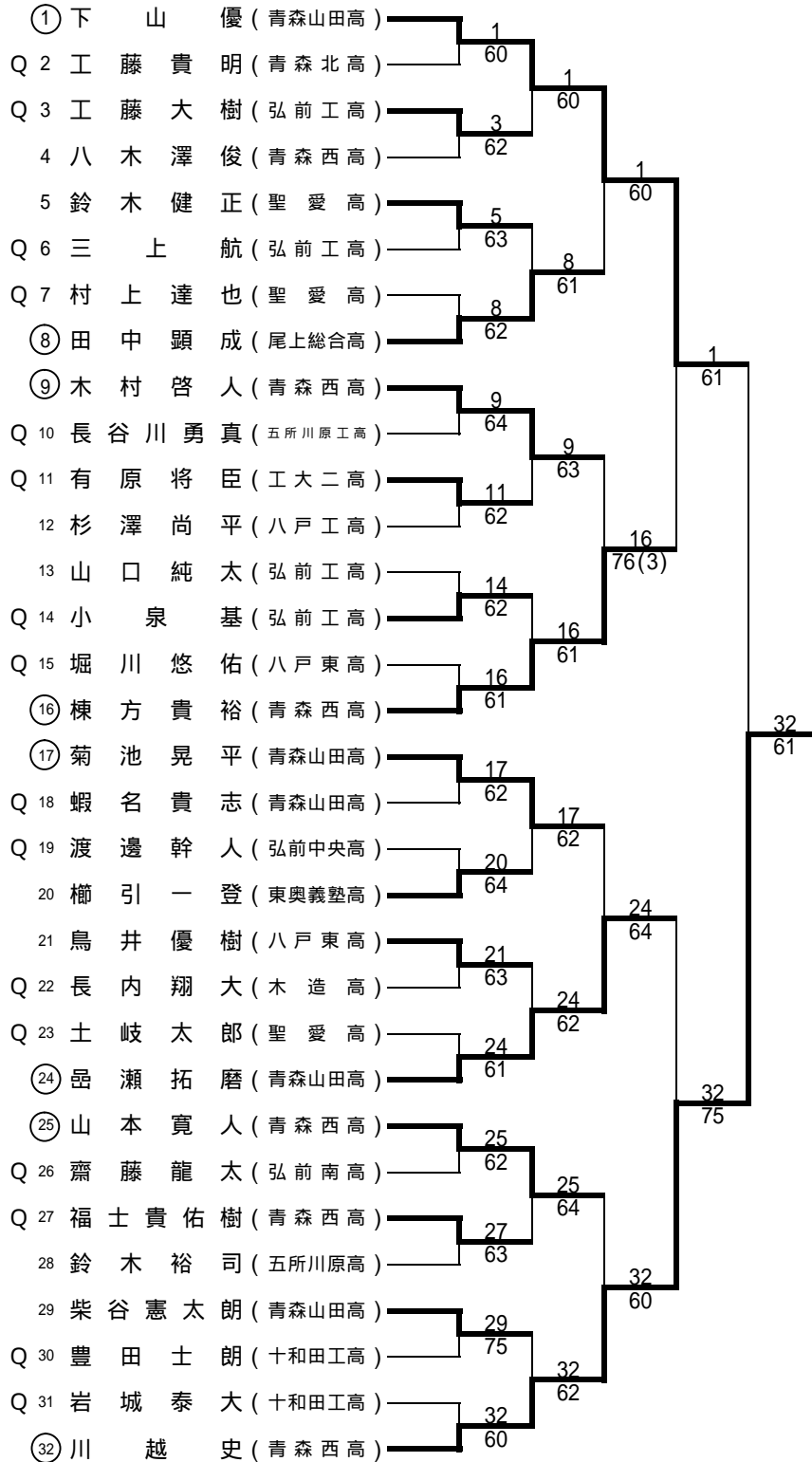

3位決定戦

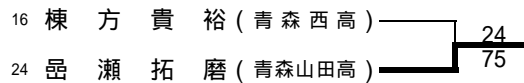

18歳以下男子シングルス予選

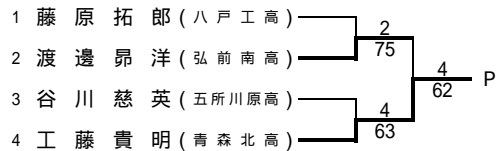
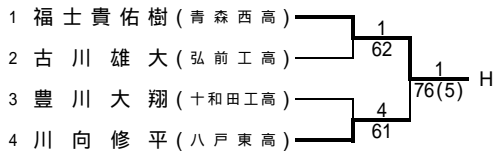
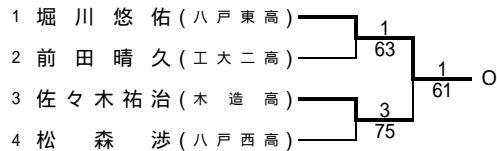
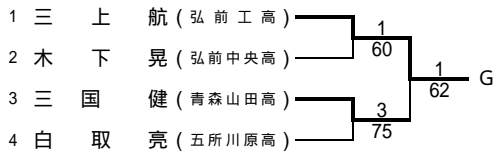
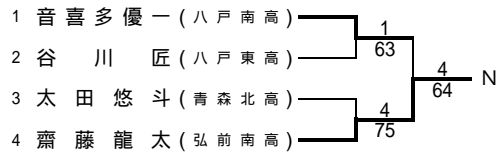
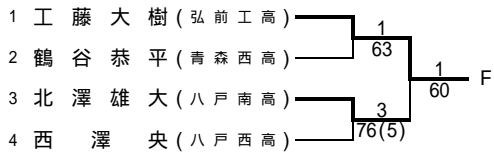
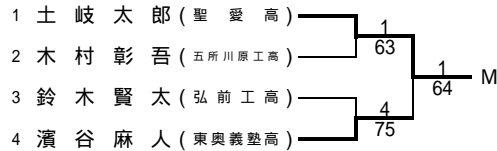
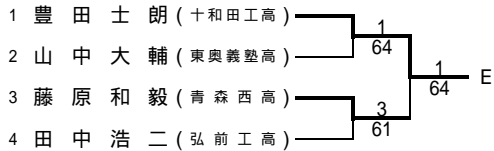
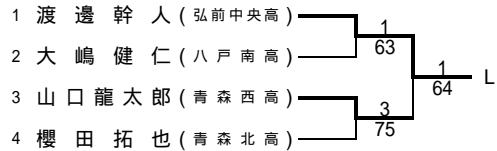
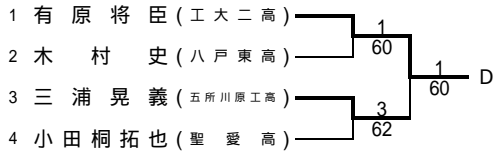
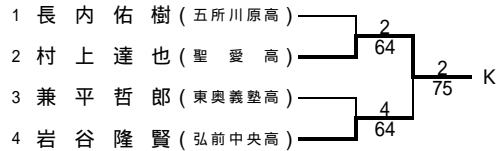
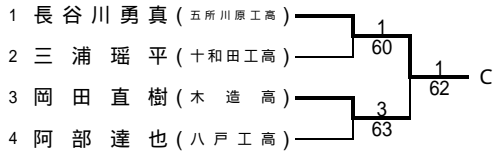
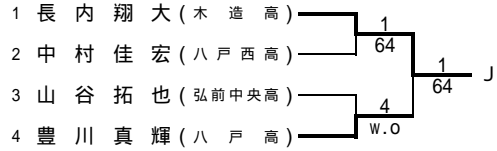
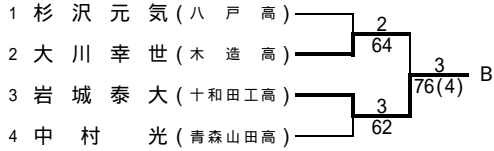
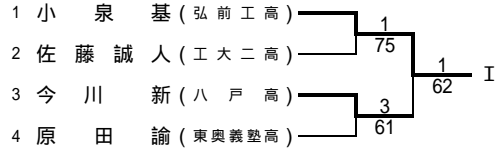
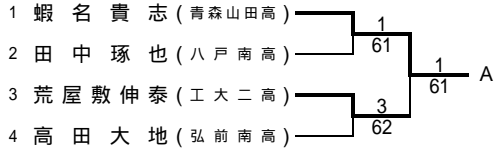

18歳以下男子ダブルス

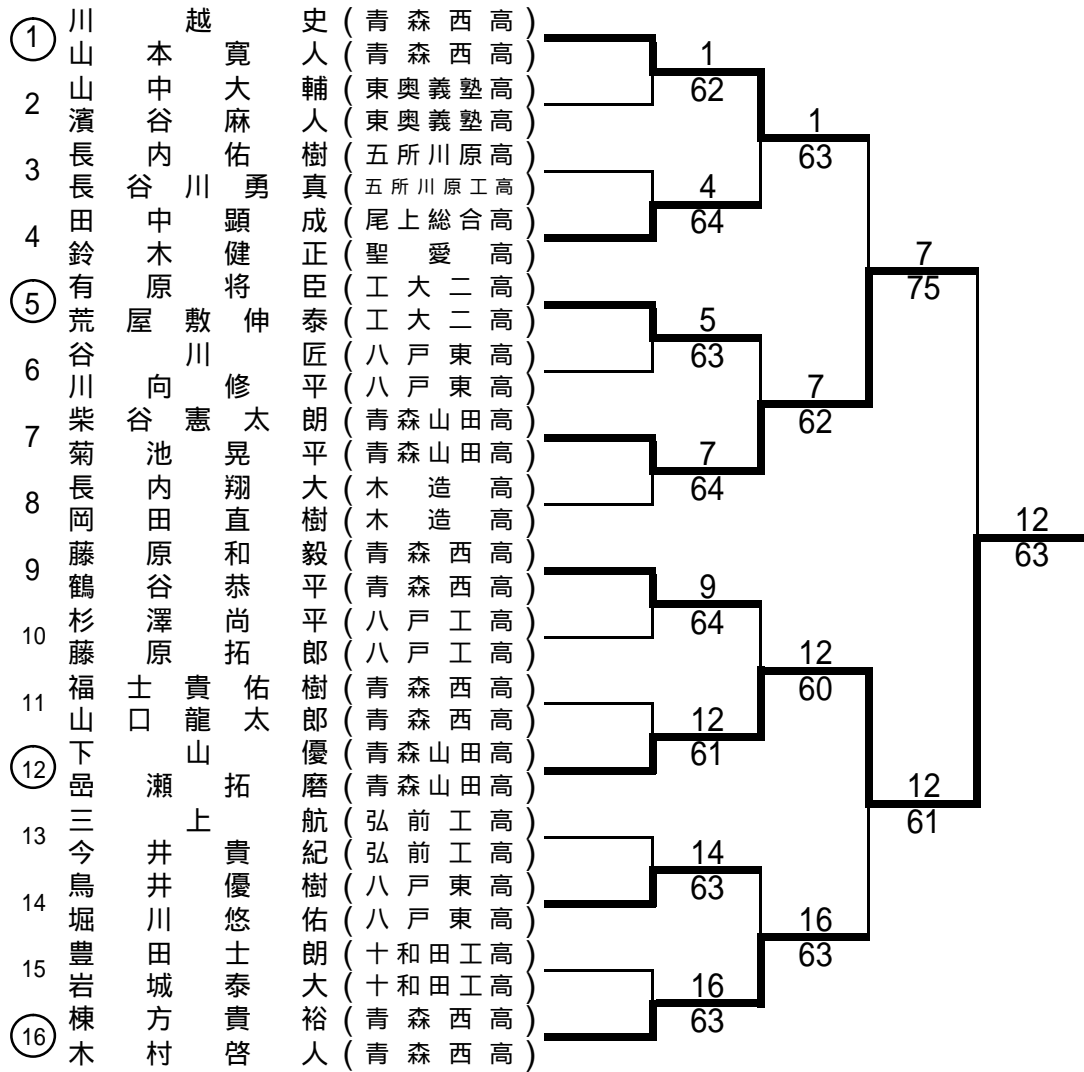

3位決定戦
 1 川山棟木 (1) 本方村寛貴啓 (16)
 16 山田 (1) 山田 (12)

18歳以下女子シングルス本選

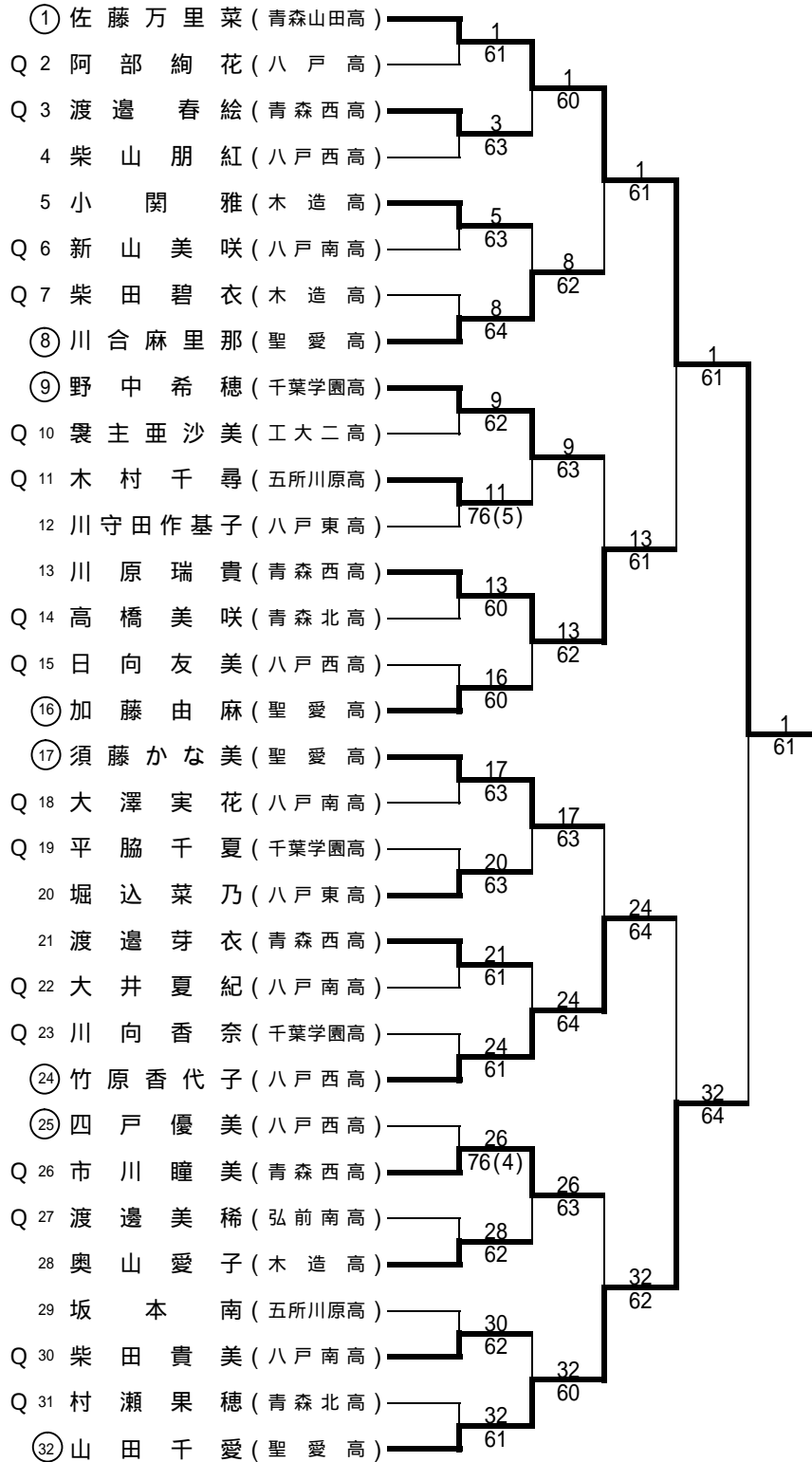

18歳以下女子シングルス予選

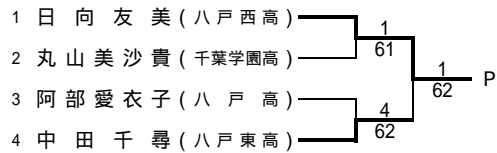
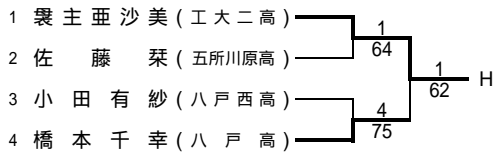
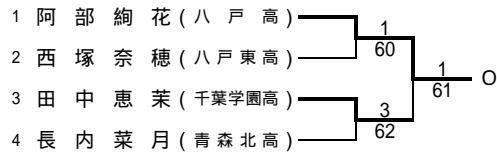
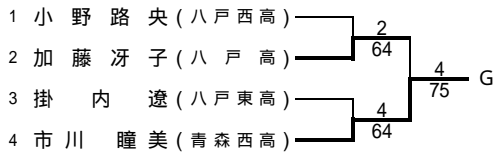
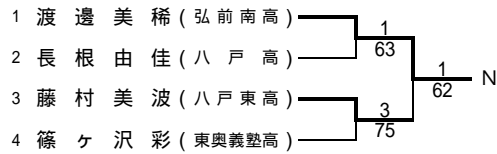
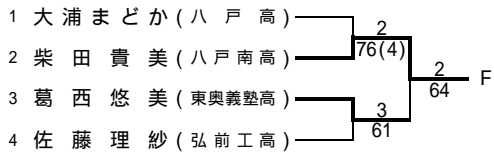
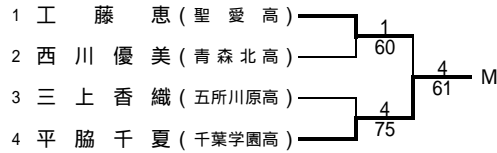
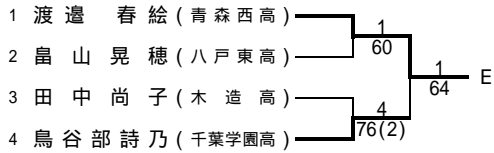
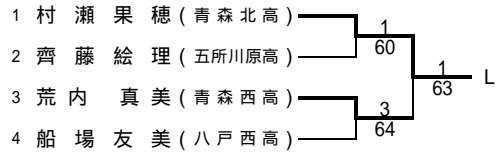
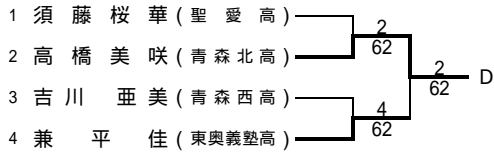
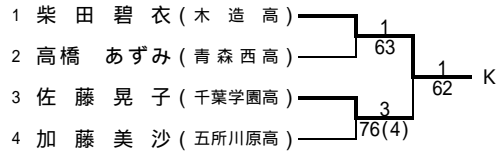
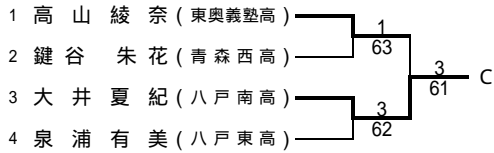
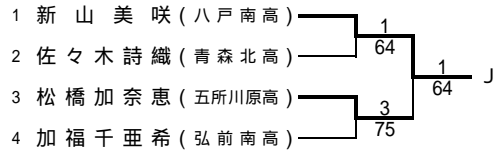
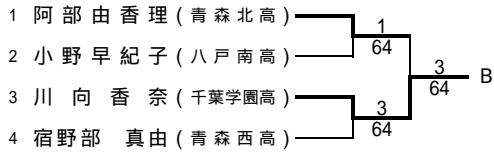
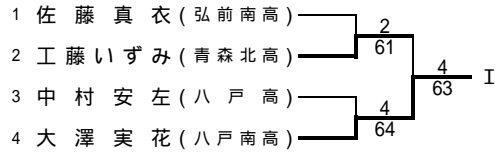
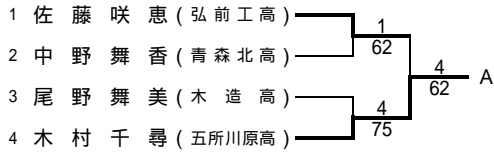

18歳以下女子ダブルス

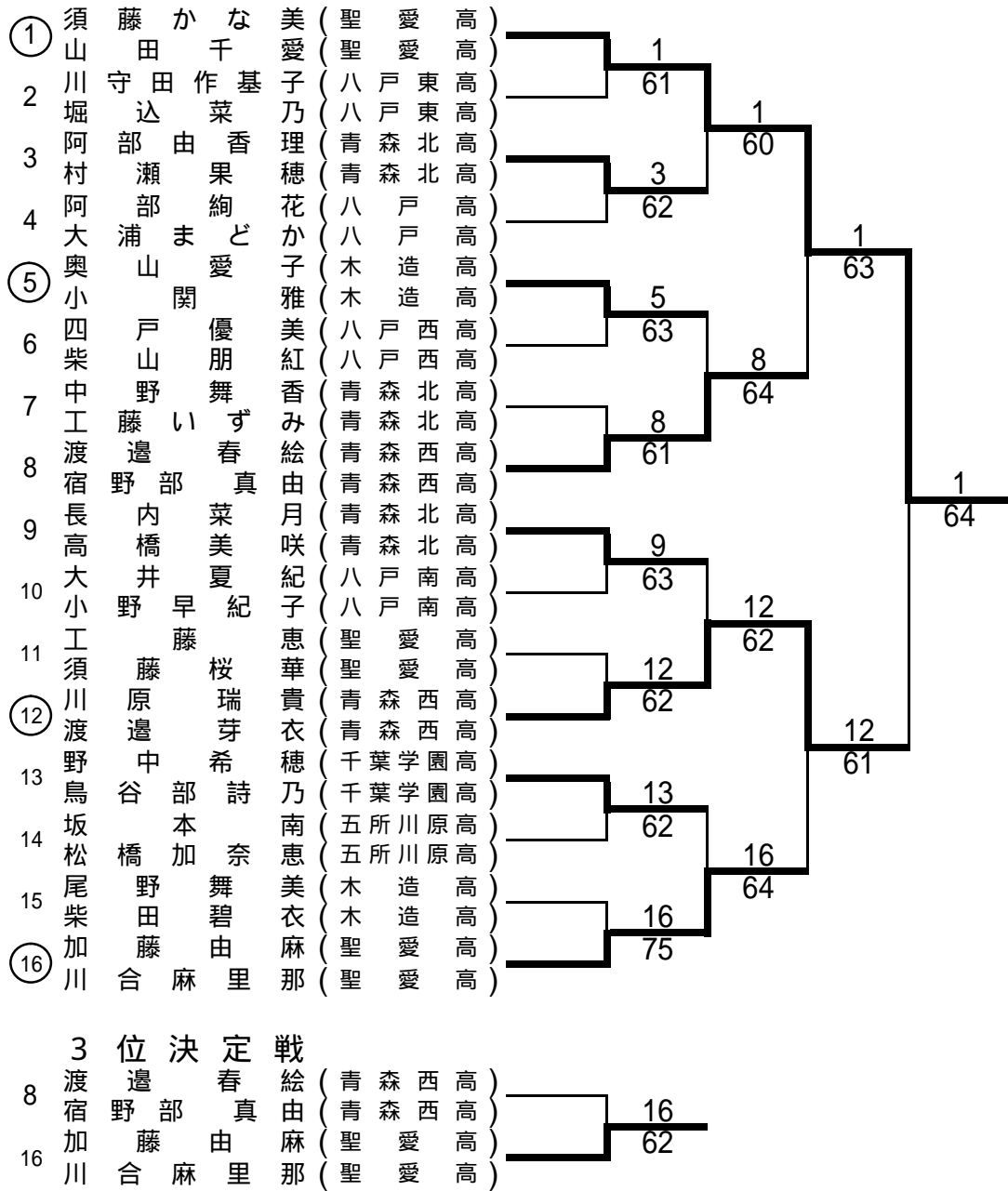

16歳以下男子シングルス本選

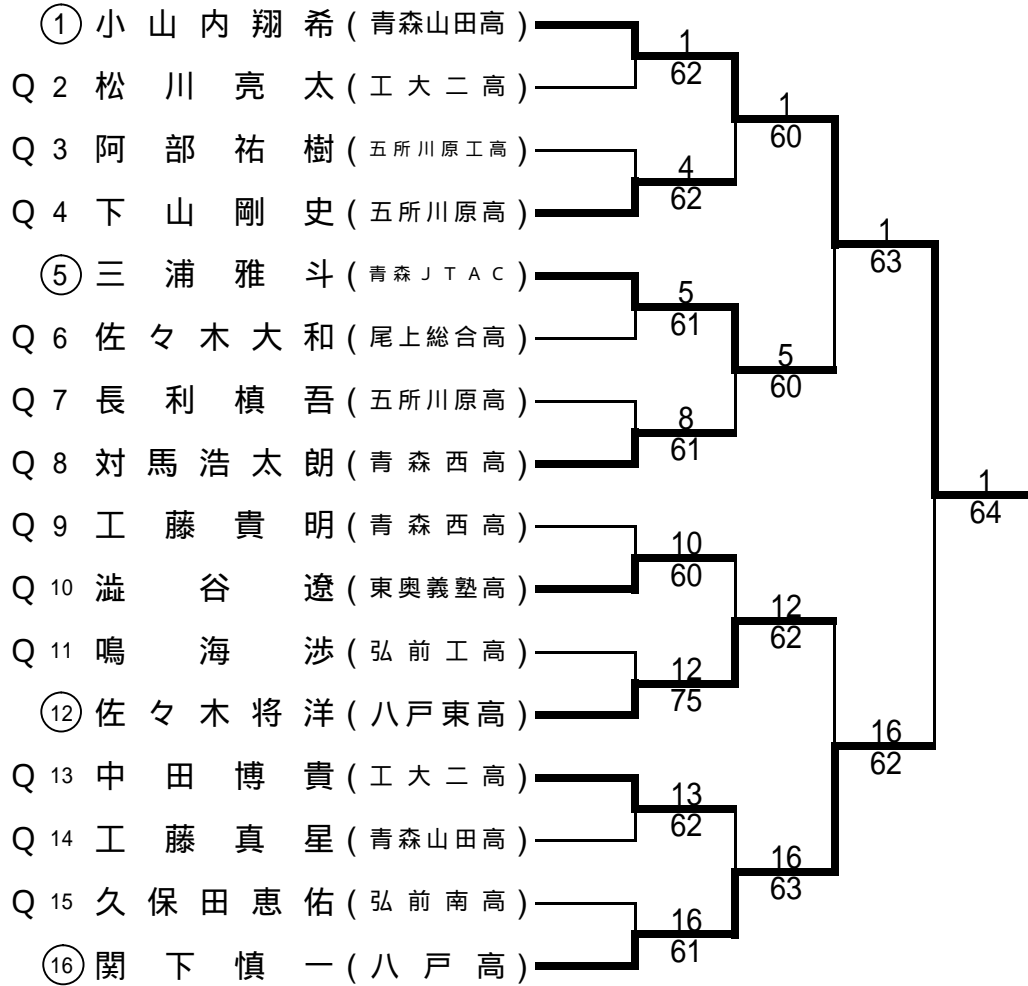

3位決定戦

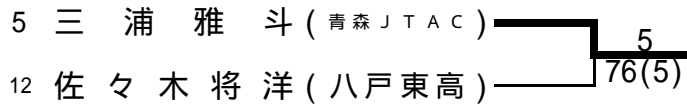

5位決定戦

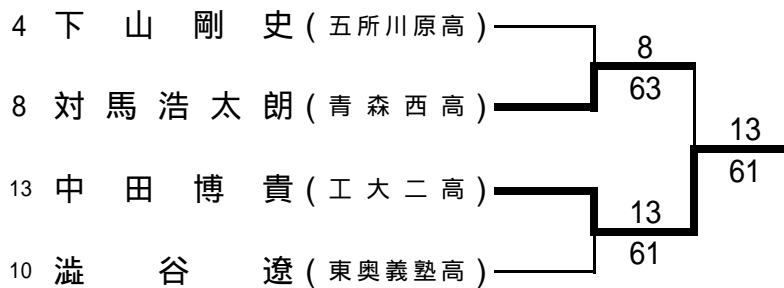

16歳以下男子シングルス予選

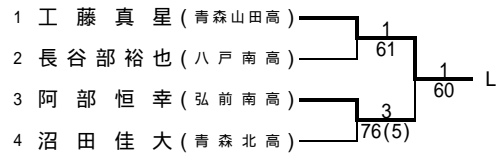
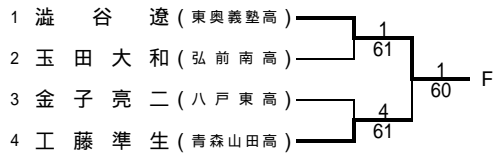
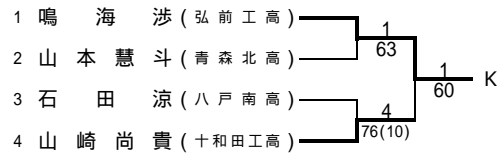
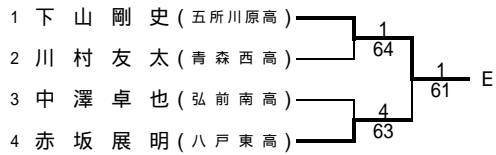
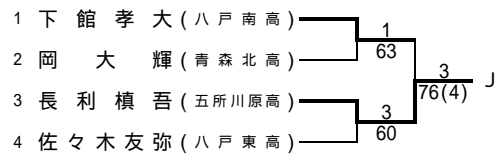
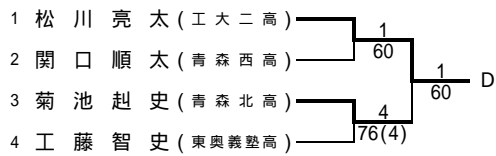
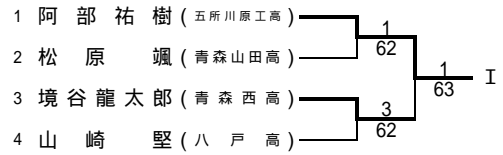
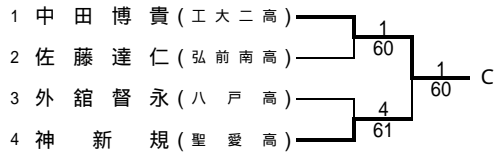
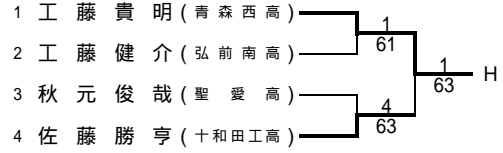
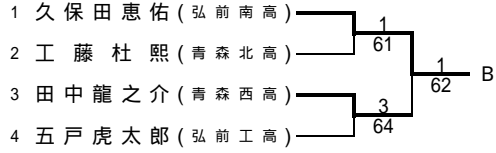
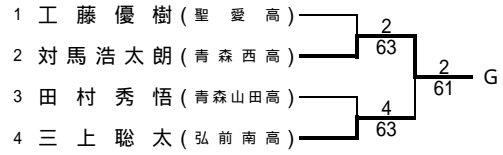
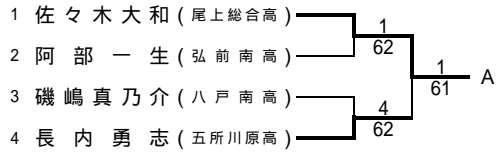

16歳以下女子シングルス本選

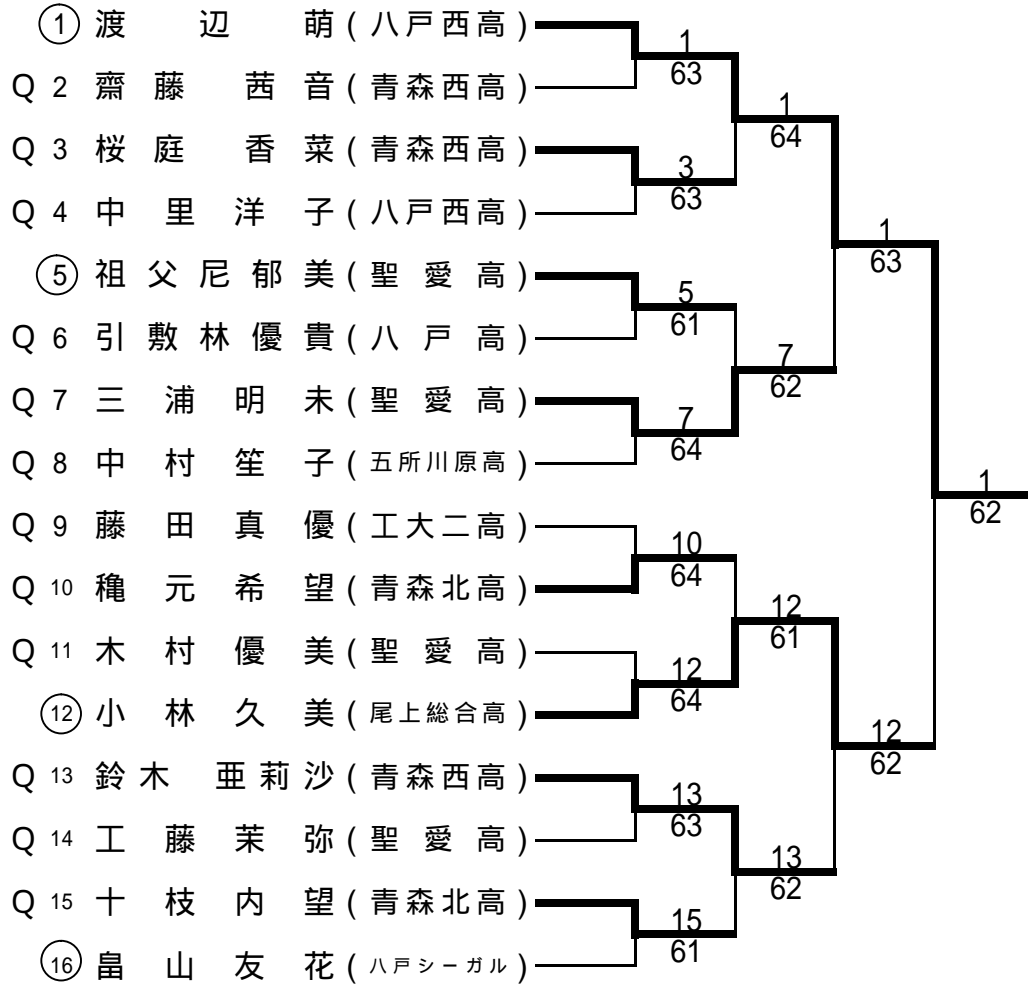

3位決定戦

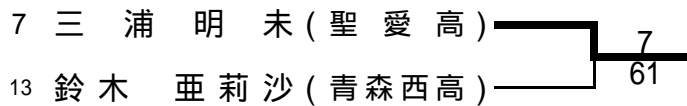

5位決定戦

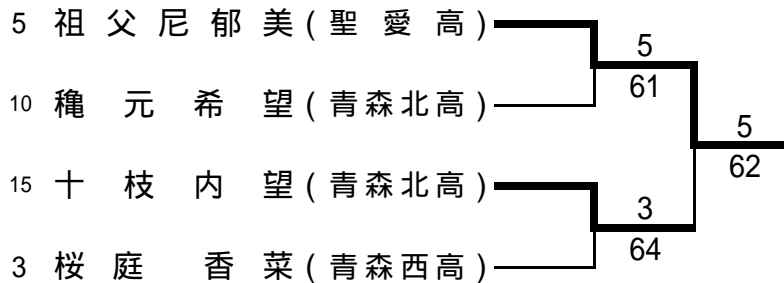

16歳以下女子シングルス予選

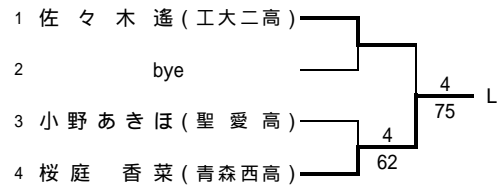
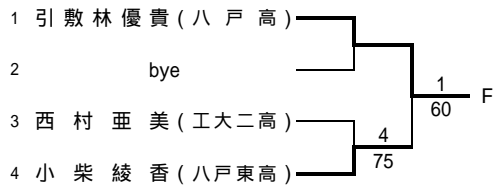
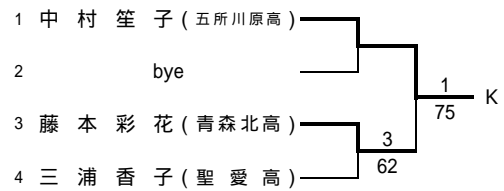
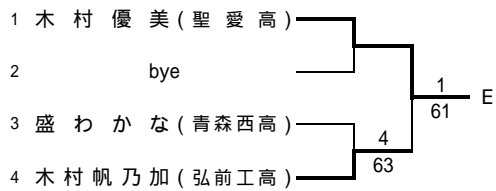
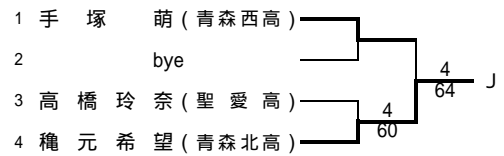
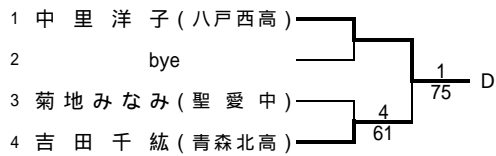
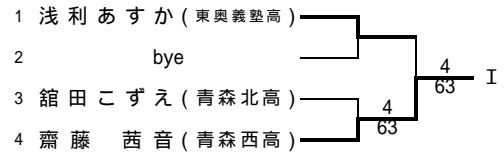
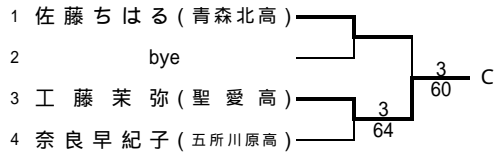
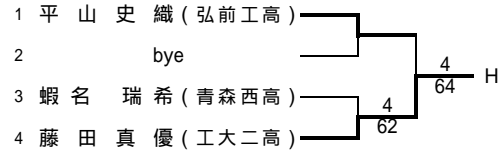
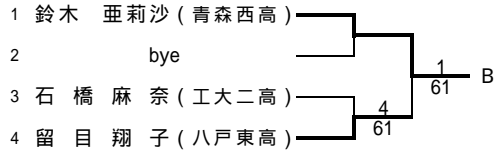
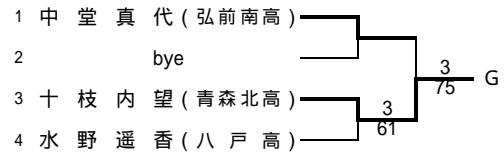
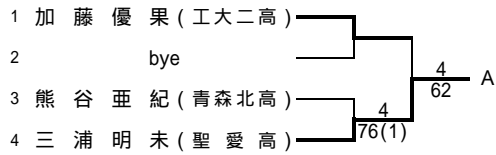

16歳以下男子ダブルス

| | | | | | | | | |
|-------|----|----|----|----|---------|----|----|----|
| ① | 関下 | 下木 | 慎将 | 一洋 | (八戸東高) | 1 | | |
| 2 | 佐々 | 館孝 | 乃 | 大介 | (八戸南高) | 64 | | |
| 3 | 磯嶋 | 真谷 | 智史 | 遼史 | (東奥義塾高) | 3 | 1 | |
| 4 | 濵工 | 藤貴 | 明之 | 介佑 | (青森西高) | 64 | 61 | |
| 5 | 田中 | 龍田 | 恵 | 太 | (弘前南高) | 5 | | 1 |
| 6 | 久三 | 上田 | 佳 | 大史 | (青森北高) | 60 | | 64 |
| 7 | 沼菊 | 池海 | 虎 | 太郎 | (弘前工高) | 8 | 8 | |
| 8 | 鳴五 | 戸博 | 亮 | 貴太 | (工大二高) | 61 | 63 | |
| ⑧ | 松川 | 亮 | 太 | 貴太 | (工大二高) | 61 | | |
| 3位決定戦 | | | | | | | | |
| 3 | 濵工 | 藤智 | 史佑 | 遼史 | (東奥義塾高) | 3 | | |
| 5 | 久三 | 保田 | 恵 | 太 | (弘前南高) | 63 | | |

16歳以下女子ダブルス

| | | | | | | | | |
|-------|----|----|----|---------|----|----|-------|--|
| ① | 鈴木 | 亜莉 | 沙萌 | (青森西高) | 1 | | | |
| 2 | 塚山 | 史乃 | 織加 | (弘前工高) | 63 | | | |
| 3 | 平村 | 帆乃 | 加 | (弘前工高) | 1 | | | |
| 4 | 佐藤 | ちは | る | (青森北高) | 4 | 1 | | |
| 5 | 吉田 | 千す | か | (青森北高) | 64 | 62 | | |
| 6 | 浅利 | あ真 | 代 | (東奥義塾高) | 6 | | 1 | |
| 7 | 中引 | 敷林 | 優 | (八戸高) | 6 | | 76(4) | |
| 8 | 水野 | 村遥 | 香子 | (八戸高) | 63 | 6 | | |
| 9 | 中奈 | 良早 | 紀 | (五所川原高) | 6 | 62 | | |
| 10 | 加藤 | 優木 | 果 | (工大二高) | 8 | | | |
| 11 | 佐々 | 木 | 遙 | (工大二高) | 8 | | | |
| 12 | 祖父 | 尼郁 | 美 | (聖愛高) | 61 | | | |
| ⑧ | 小林 | 久美 | 美 | (尾上総合高) | 61 | | | |
| 3位決定戦 | | | | | | | | |
| 4 | 浅利 | あ真 | 代 | (東奥義塾高) | 8 | | | |
| 8 | 中引 | 敷林 | 優 | (八戸高) | 61 | | | |