

18歳以下男子シングルス本選

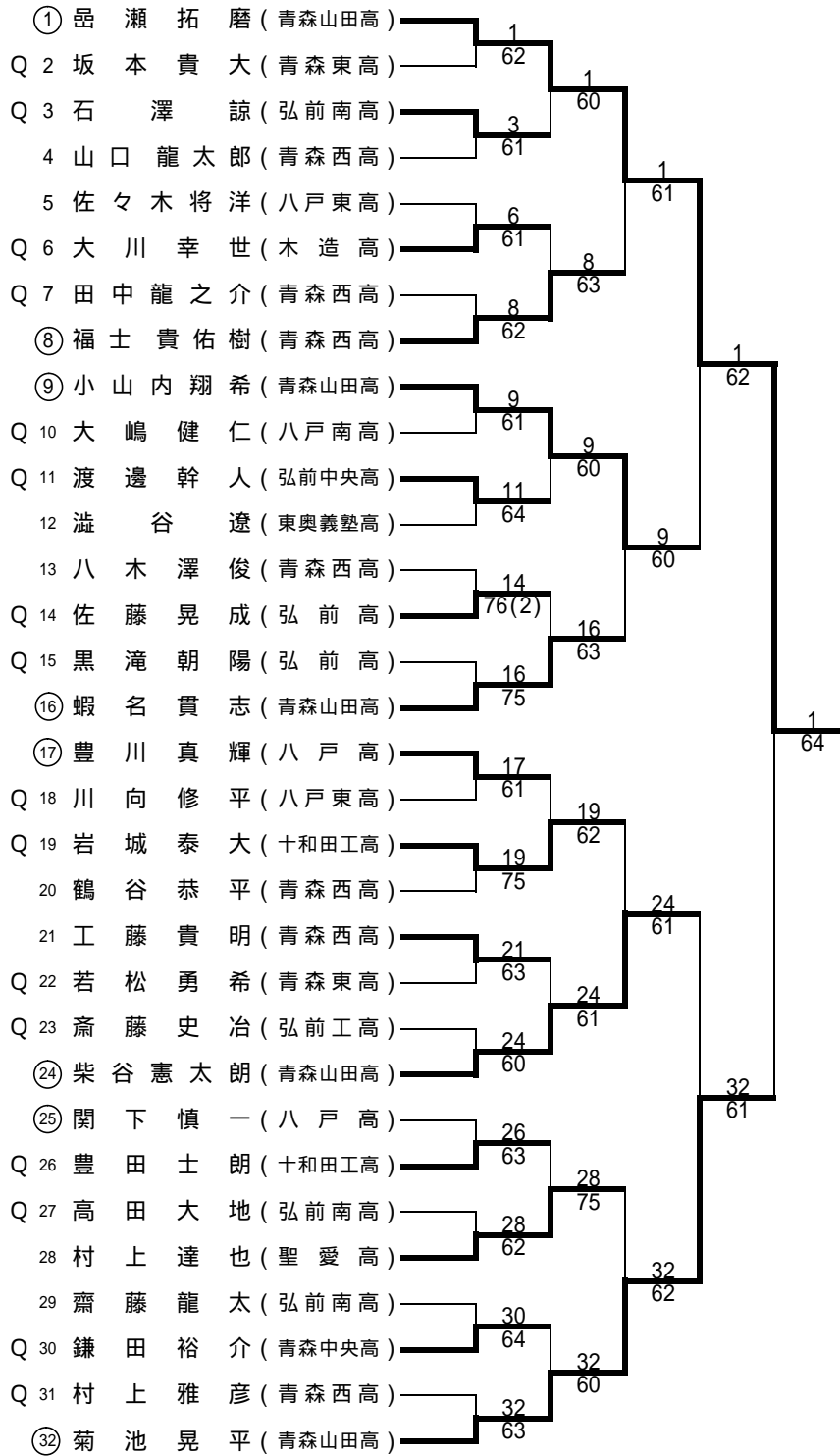

3位決定戦

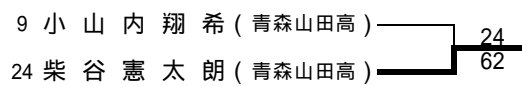

18歳以下男子シングルス予選

1 大川幸世(木造高)	1		A
2 三浦瑠平(十和田工高)	60		
3 秋元一志(弘前高)	3		
4 小田桐拓也(聖愛高)	63		

1 川向修平(八戸東高)	1		B
2 白戸祐也(五所川原高)	61		
3 淡路拓也(南部工高)	3		
4 田村秀悟(青森山田高)	75		

1 高田大地(弘前南高)	1		C
2 阿部祐樹(五所川原工高)	62		
3 葛西晃(弘前中央高)	3		
4 工藤智史(東奥義塾高)	61		

1 村上雅彦(青森西高)	1		D
2 佐伯和磨(尾上総合高)	64		
3 長谷部裕也(八戸南高)	3		
4 吉田翔(八戸高)	62		

1 渡邊幹人(弘前中央高)	1		E
2 加藤勇人(青森中央高)	60		
3 鳴海渉(弘前工高)	4		
4 島守泰地(八戸東高)	64		

1 松倉大樹(南部工高)	1		F
2 関楠矢(八戸西高)	60		
3 岩城泰大(十和田工高)	3		
4 神大輔(弘前南高)	62		

1 小田切駿(弘前高)	2		G
2 三橋郁夫(青森北高)	62		
3 高橋涼(工大二高)	4		
4 田中龍之介(青森西高)	62		

1 黒滝朝陽(弘前高)	1		H
2 神新規(聖愛高)	64		
3 青山文平(五所川原高)	4		
4 沢田陽希(木造高)	62		

1 若松勇希(青森東高)	1		I
2 兼平哲郎(東奥義塾高)	63		
3 木村彰吾(五所川原工高)	4		
4 山谷拓也(弘前中央高)	63		

1 豊田士朗(十和田工高)	1		J
2 山崎堅(八戸高)	61		
3 三浦允人(尾上総合高)	4		
4 釜宗貴(南部工高)	64		

1 中田博貴(工大二高)	1		K
2 境谷龍太郎(青森西高)	60		
3 花田隆史(青森中央高)	4		
4 佐藤晃成(弘前高)	60		

1 下山剛史(五所川原高)	1		L
2 津島彰仁(木造高)	63		
3 田中浩二(弘前工高)	4		
4 坂本貴大(青森東高)	64		

1 三浦晃義(五所川原工高)	1		M
2 宮本祥太(八戸東高)	75		
3 大嶋健仁(八戸南高)	3		
4 濱舘聡(八戸工高)	61		

1 佐々木大和(尾上総合高)	2		N
2 石澤諒(弘前南高)	61		
3 富田瑛一郎(八戸西高)	3		
4 太田悠斗(青森北高)	def		

1 鎌田裕介(青森中央高)	1		O
2 明戸慎(工大二高)	63		
3 三戸倭(青森北高)	4		
4 三浦直紀(八戸西高)	64		

1 斎藤史治(弘前工高)	1		P
2 中澤卓也(弘前南高)	61		
3 森外学睦(八戸工高)	4		
4 磯嶋真乃介(八戸南高)	63		

18歳以下男子ダブルス

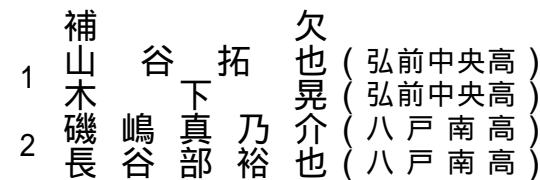
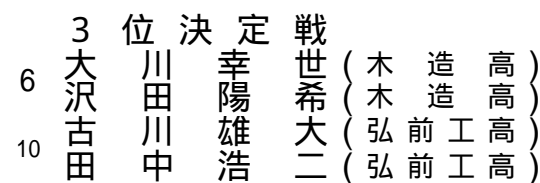
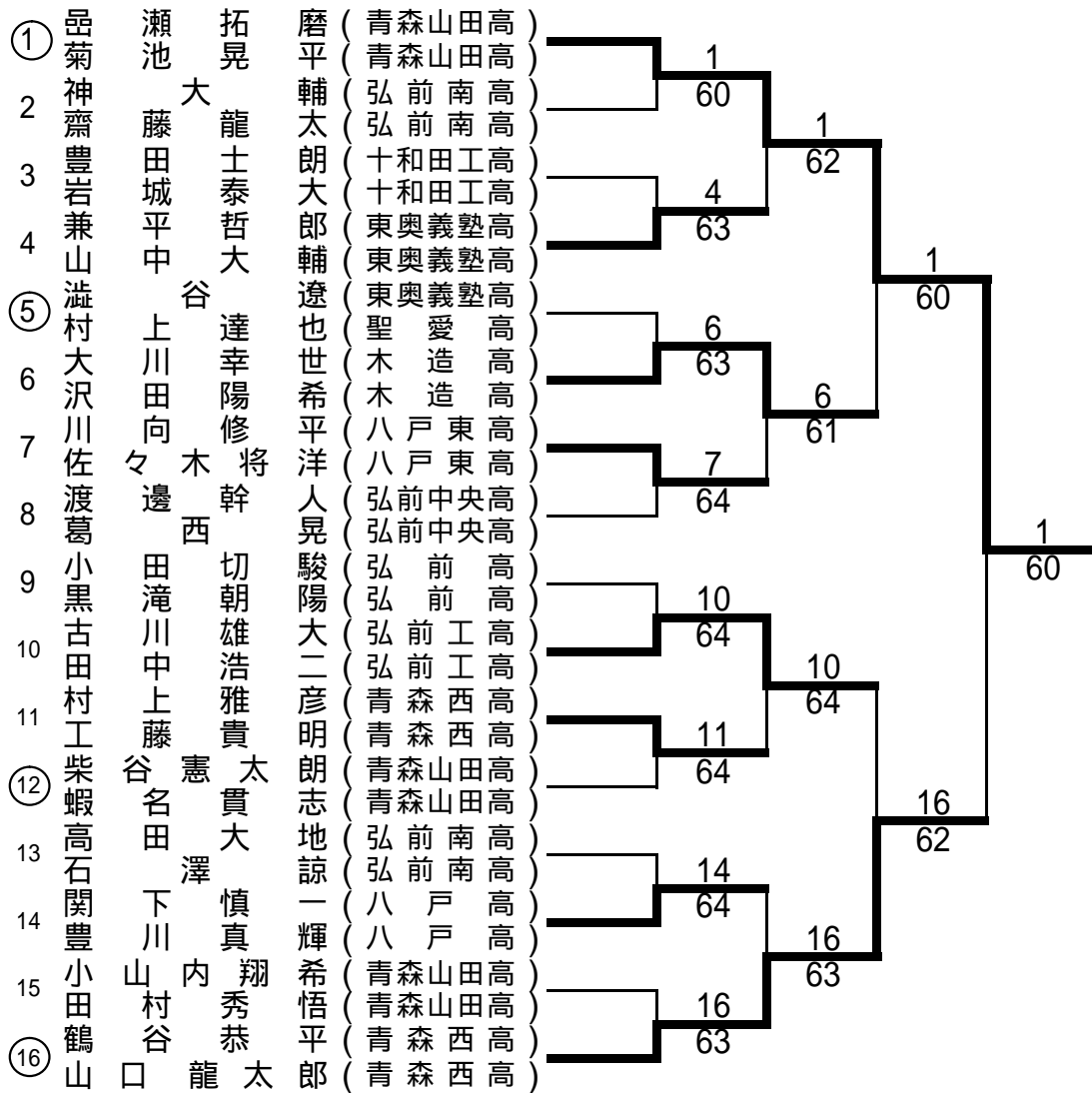

18歳以下女子シングルス本選

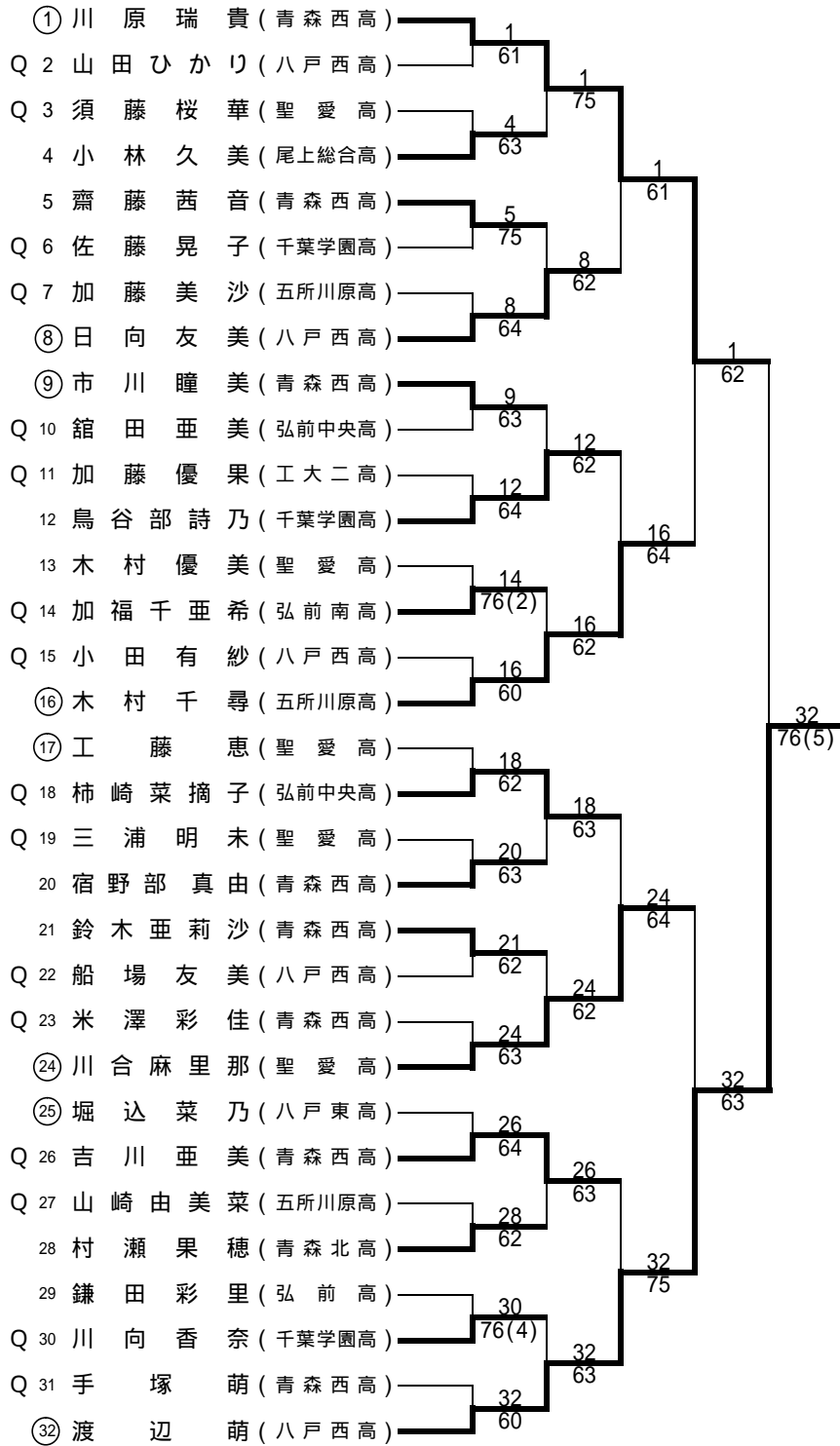

3位決定戦

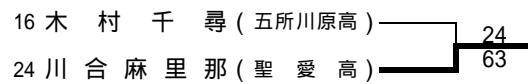

18歳以下女子シングルス予選

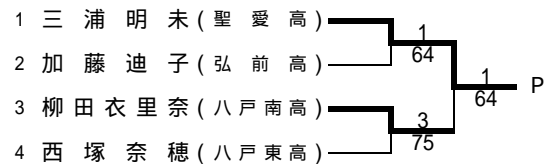
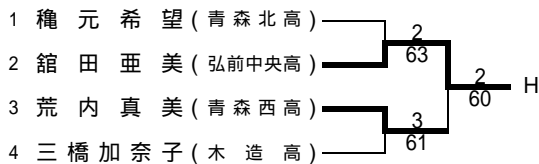
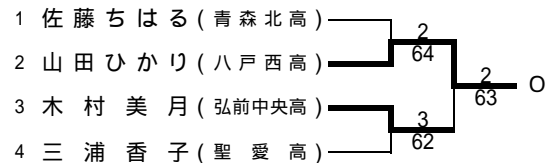
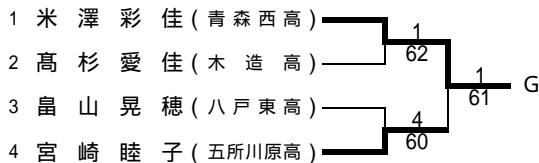
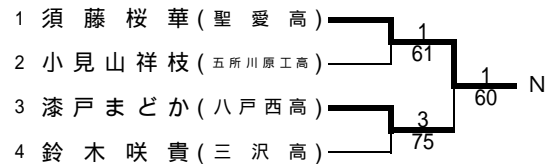
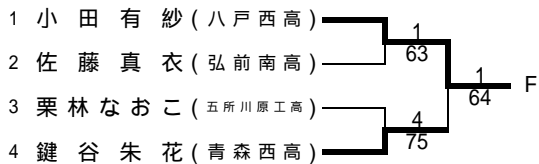
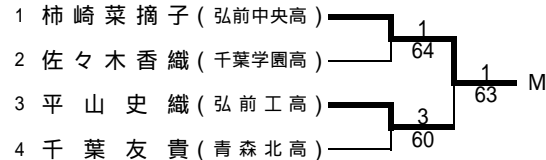
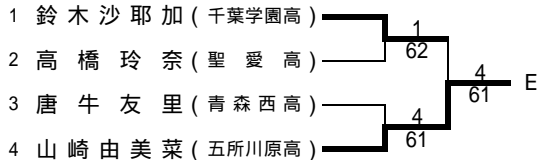
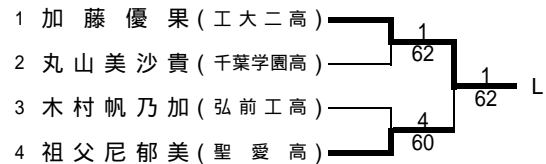
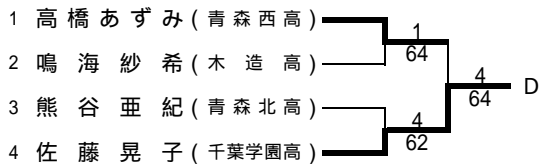
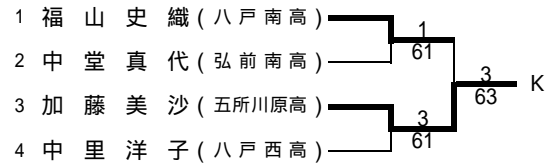
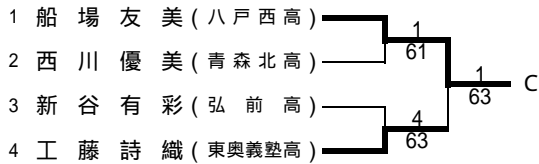
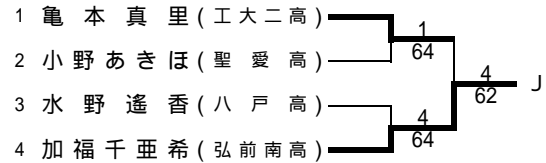
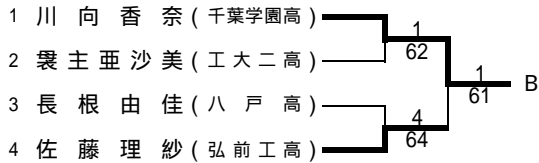
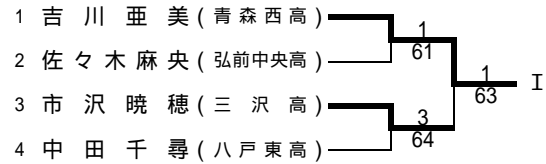
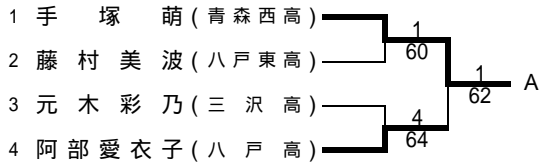

16歳以下男子シングルス本選

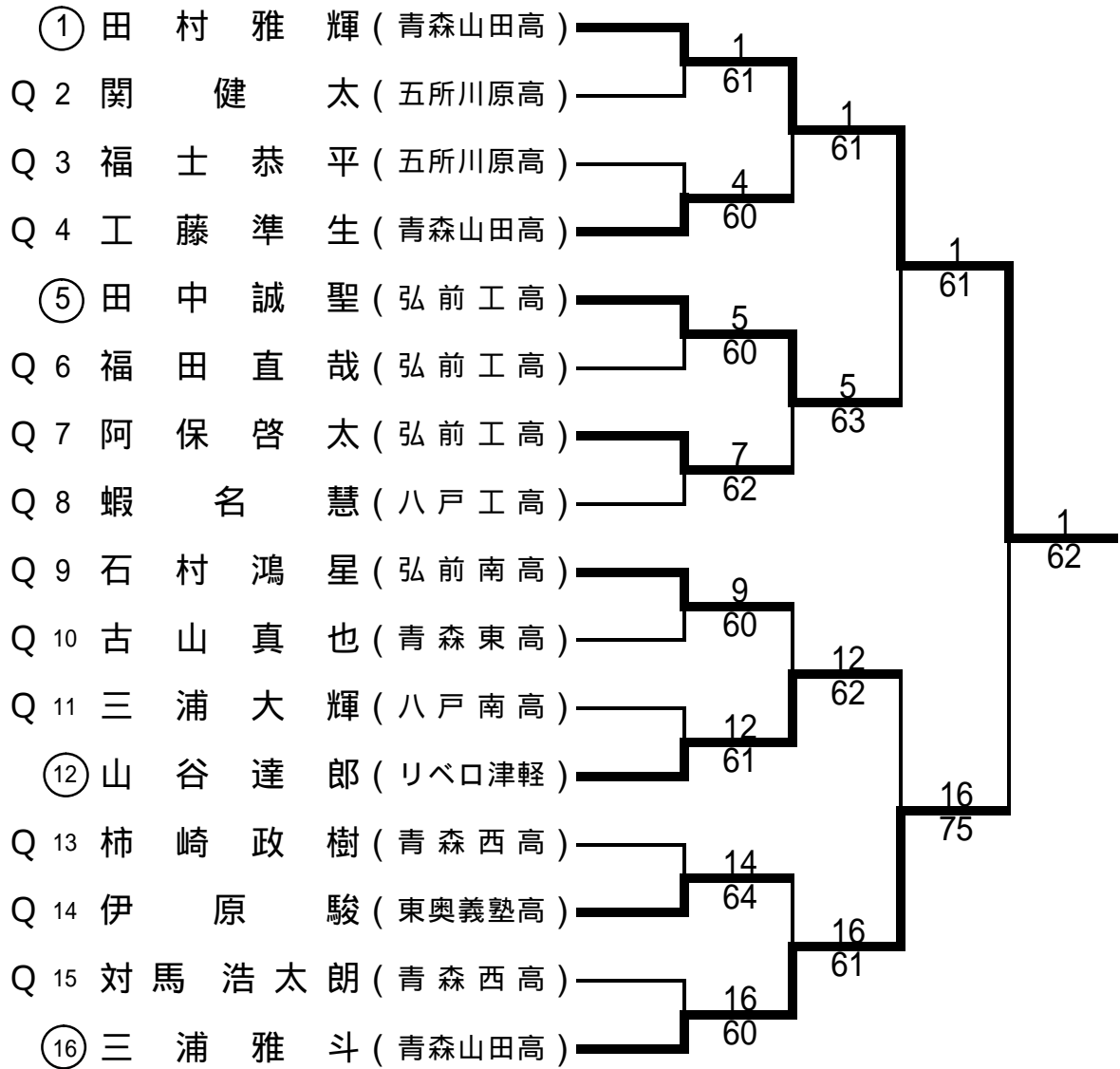

3位決定戦

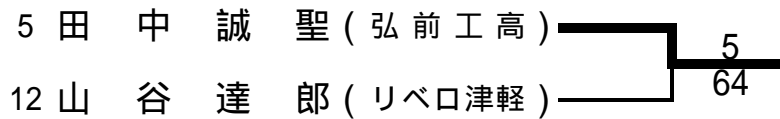

16歳以下男子シングルス予選

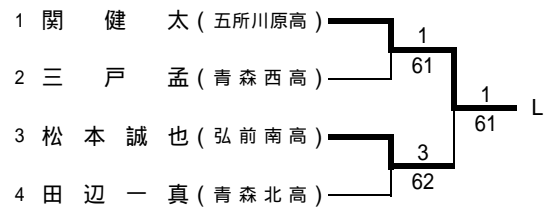
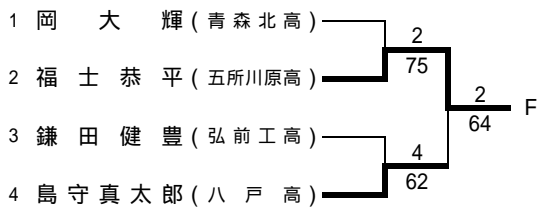
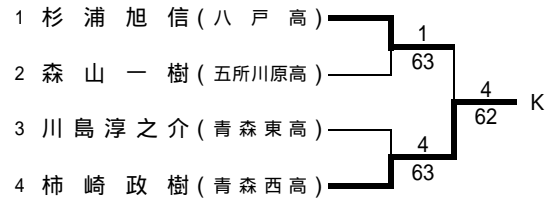
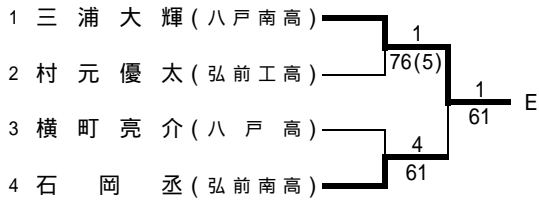
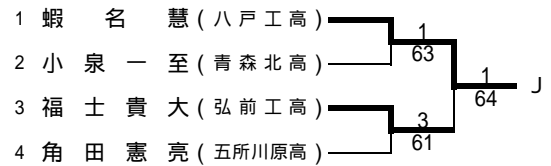
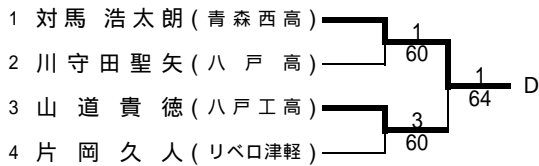
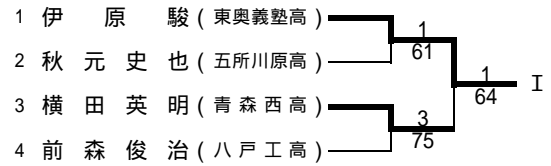
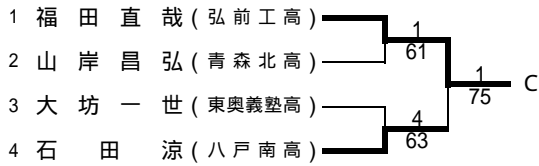
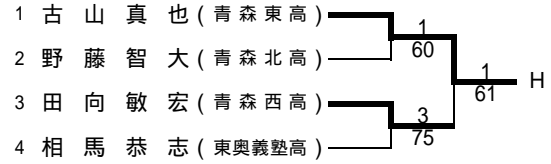
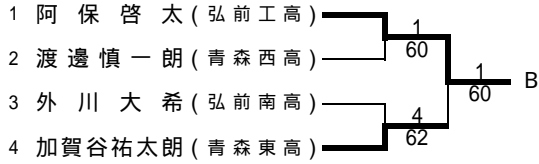
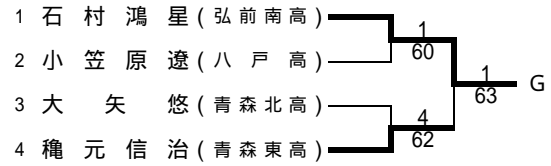
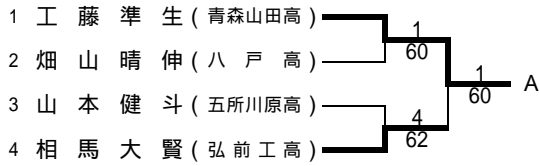

16歳以下男子ダブルス

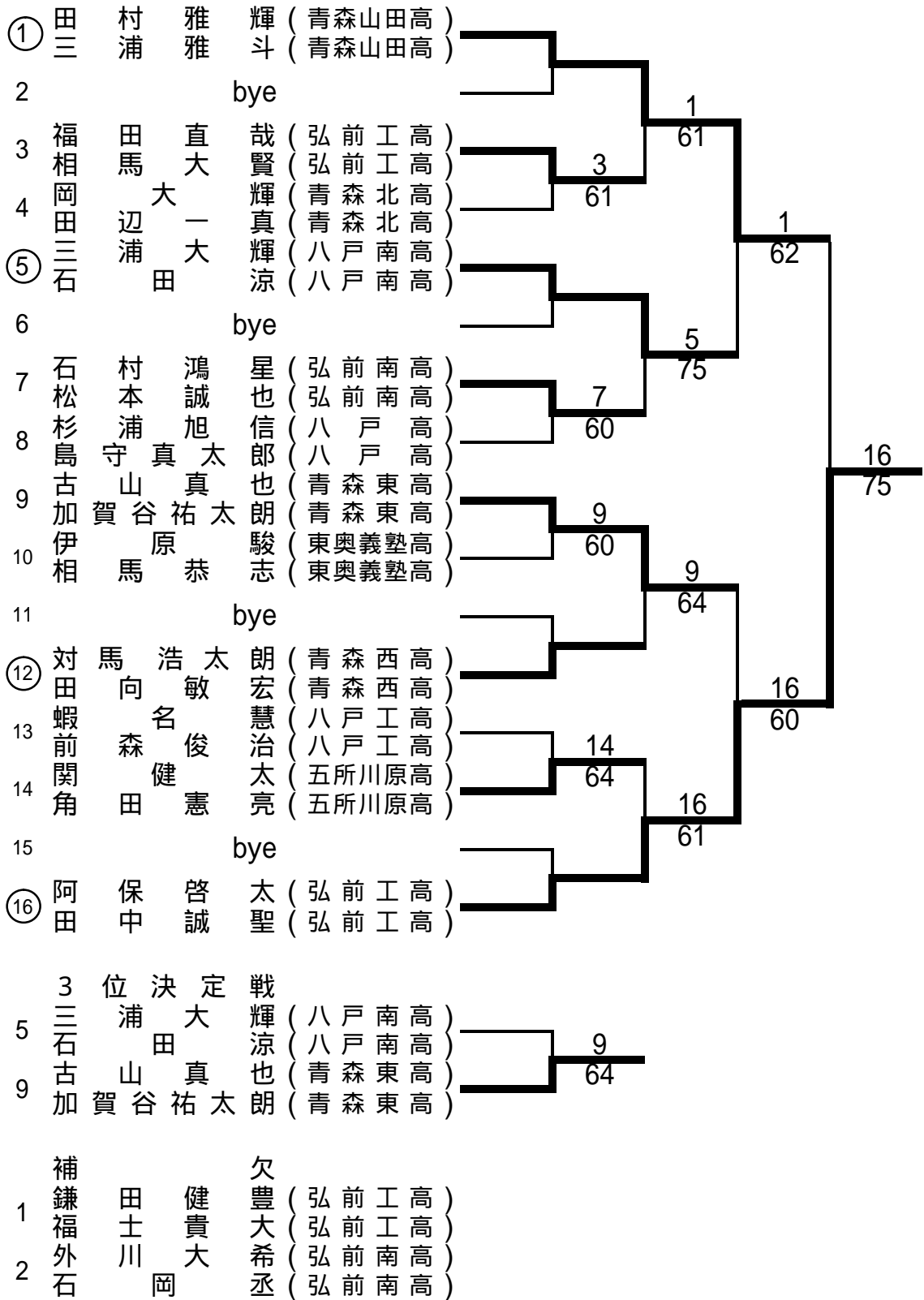

16歳以下女子シングルス本選

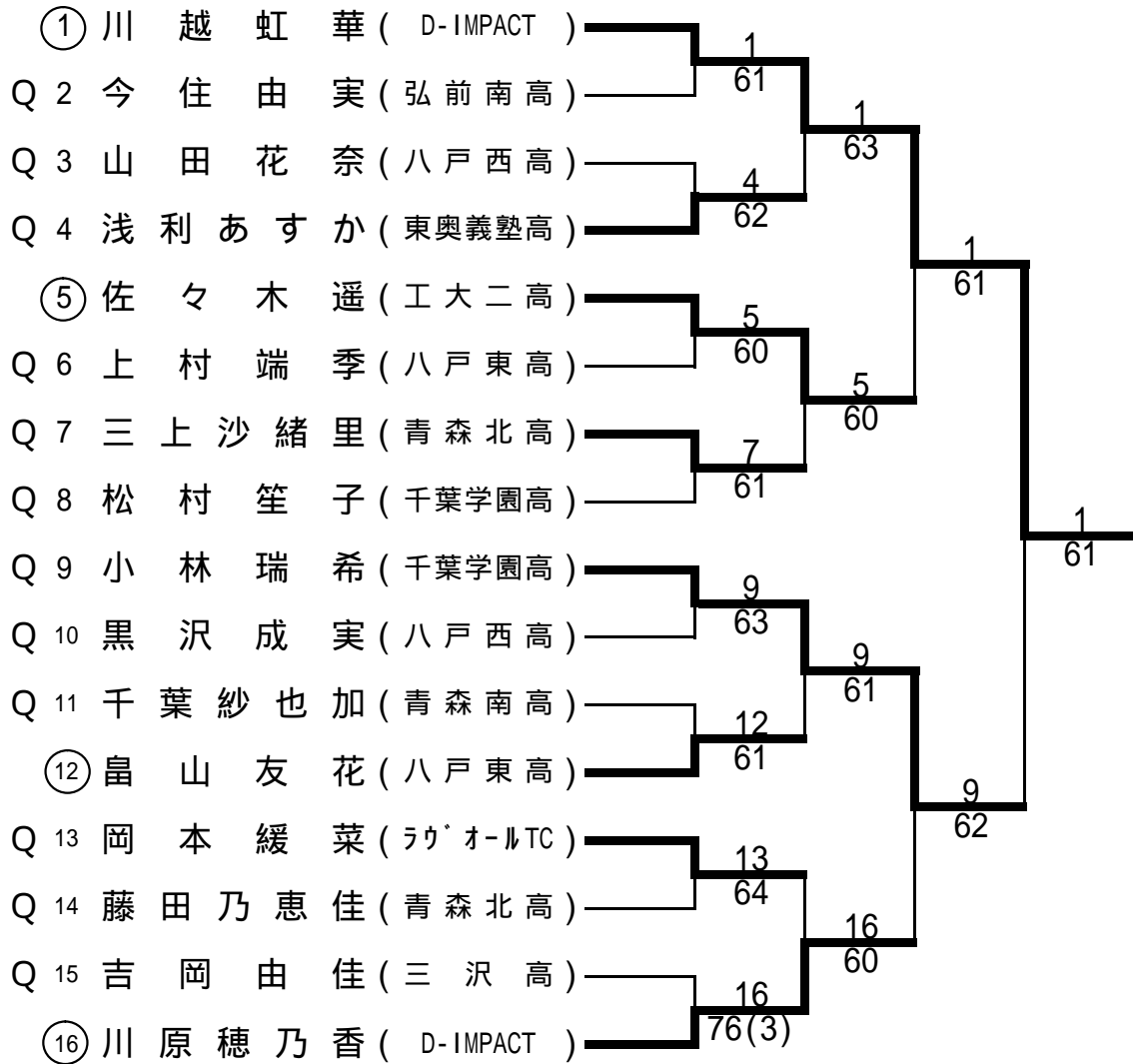

16歳以下女子シングルス予選

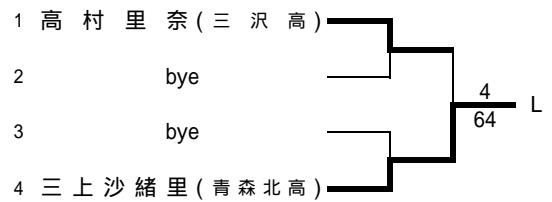
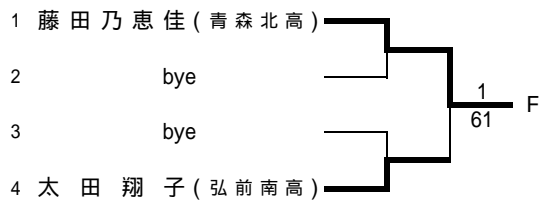
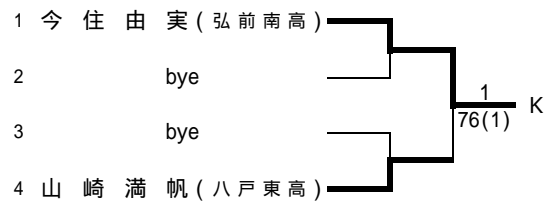
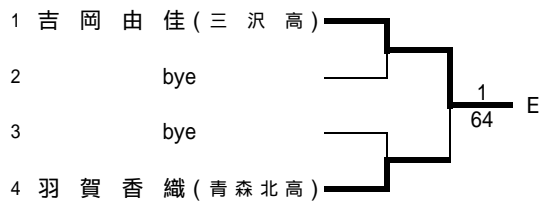
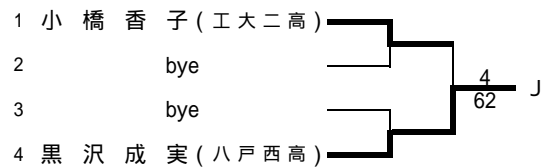
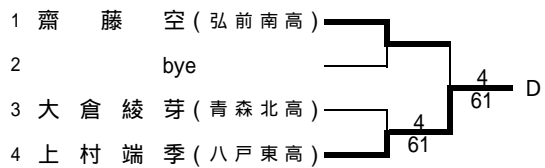
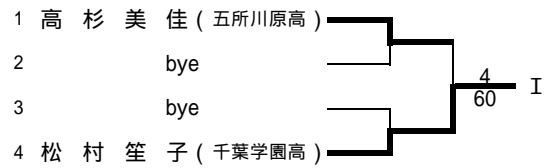
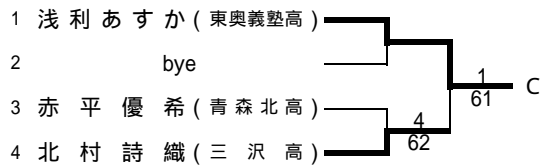
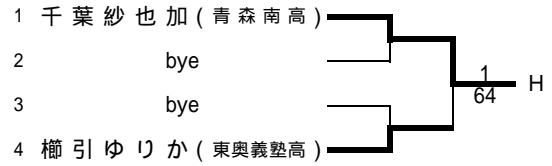
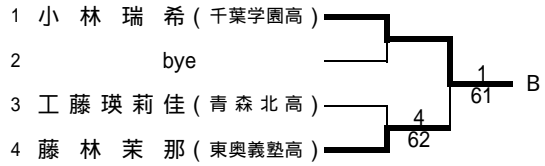
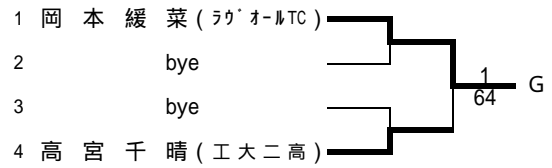
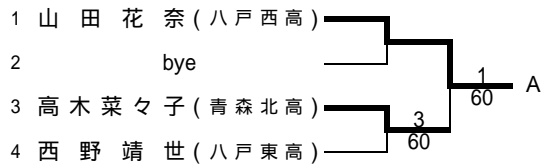

16歳以下女子ダブルス

